

Business & Market Outlook

Mar, 2013



Disclaimer

From the first quarter of 2012, this material shows business results and related substances by 3 divisions(Petrochemicals, I&E Materials and Energy Solution) and thus past figures are revised to a same basis.

The business results are subject to the IFRS(International Financial Reporting Standards) from 2010. In addition, operating profits for 2011 and 2012 are amended to reflect revisions of “K-IFRS, No. 1001” decided on 19th regular Financial Services Commission’s meeting on October 17th, 2012.

Forecasts and projections contained in this material are based on current business environments and management’s strategies, and they may differ from the actual results upon changes and unaccounted variables.

Table of Contents

LG Chem at Glance	1
4Q 2012 Business Results	3
Divisional Results & Outlook	5
2013 Business Plan	7
Appendix	9

LG Chem at a Glance

- LG Chem was started in 1947 and is Korea's first and largest chemical company with an established track of over 60 years and annual revenues of KRW 23.3 trillion in 2012.
- LG Chem boasts multiple production facilities and an extensive distribution network that spans 15 countries worldwide in Asia, Europe, North and South America.
- LG Chem currently holds the largest vertically integrated petrochemical production platform in Korea.
- LG Chem was reborn as a specialized and diversified chemical company that focuses on petrochemical goods, rechargeable batteries including HEV/EV purpose, OLED materials, and 3D FPR.
- LG Chem will seek operational excellence in its core business and centralize its resources with new business such as HEV/EV batteries and LCD glass substrates to reinforce the necessary momentum for future growth.
- Despite high uncertainties remaining in the business environment such as a delayed recovery in the global economy, LG Chem recorded historically the highest sales in 2012.

Impressive Revenue Scale..*

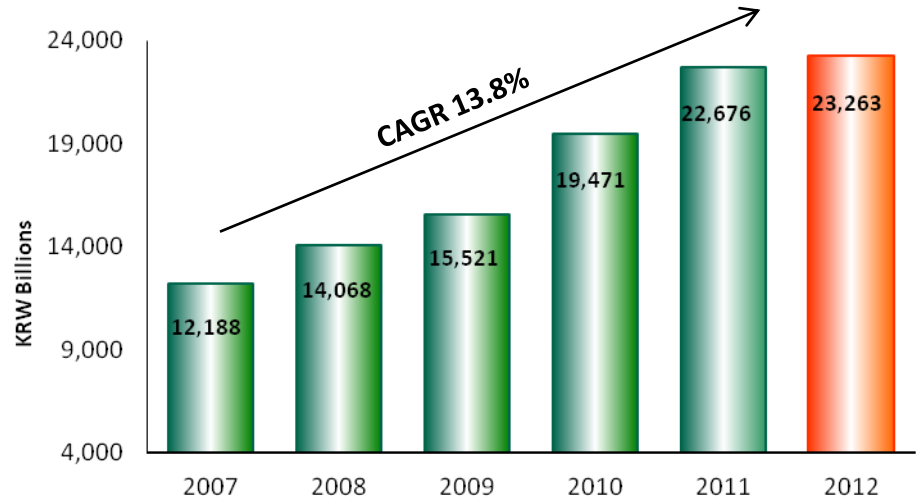

...with Strong EBIT & EBIT Margins*

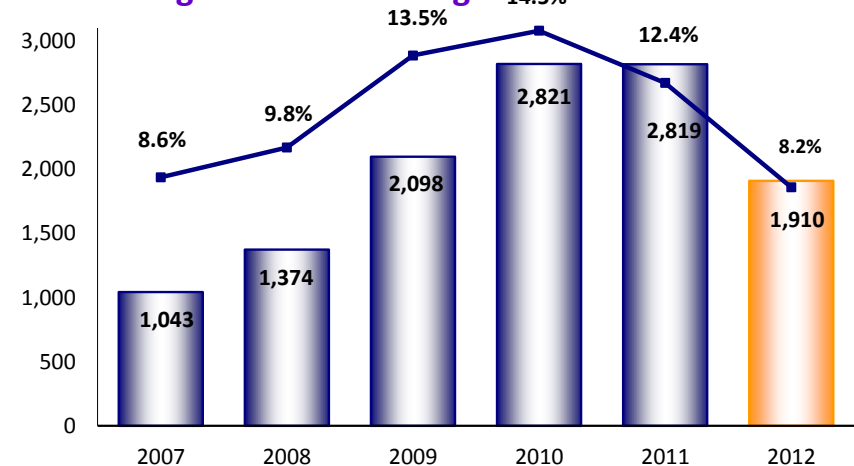

* Sales and EBIT are subject to IFRS from 2009. Those prior to 2009 are subject to K-GAAP(consolidated base).

Differentiated Competitiveness

Vertical Integration Structure

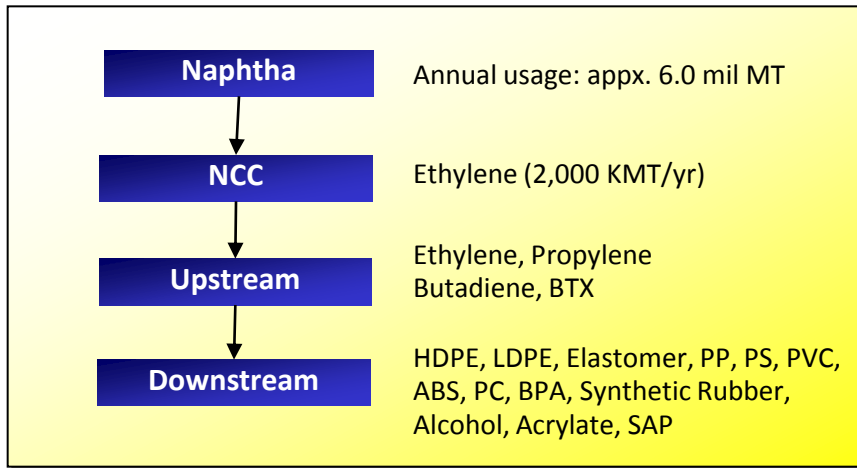

Co-existence of upstream and downstream products

- One of few petrochemical companies around the globe with vertical integration structure, featuring both upstream and downstream production capability.
- This structural characteristic delivers stable business performance against industry cyclicality.

Comprehensive downstream product lines

LG Chem's comprehensive downstream product lines of PO, ABS, PVC and other various products have complementary business cycles, enabling the Company to generate stable revenue



Stabilized revenue generating capability under any market conditions

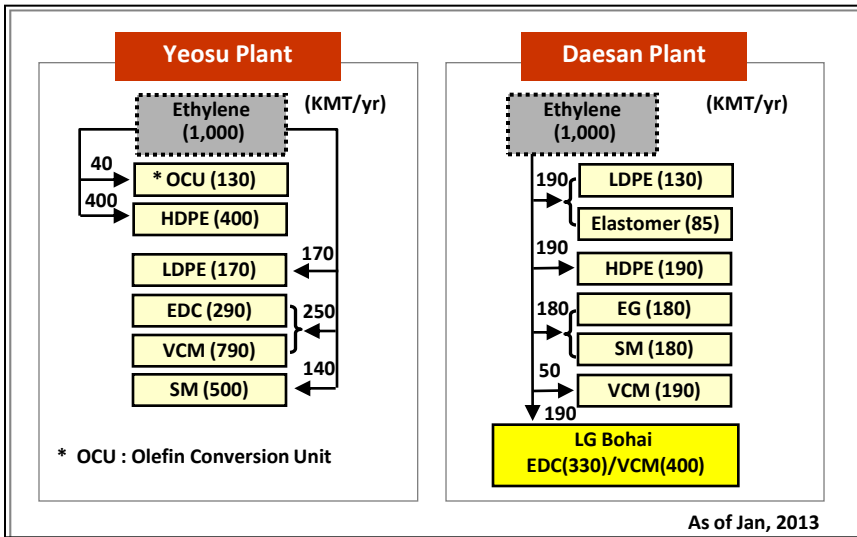

(Unit: KRW bn)

Classification	'11.4Q	'12.3Q	'12.4Q	YoY	QoQ
Sales	5,599	5,834	5,681	1.5%	-2.6%
Operating Profit	508	601	364	-28.4%	-39.4%
(%)	(9.1)	(10.3)	(6.4)		
Pre-tax Income	502	585	375	-25.3%	-35.9%
(%)	(9.0)	(10.0)	(6.6)		
Net Income	377	459	292	-22.5%	-36.4%

Financial Position

(Unit: KRW bn)

Classification	'11	'12	Change
Asset	15,286	16,581	8.5%
Cash and equivalents	1,379	1,341	-2.8%
Liabilities	5,578	5,816	4.3%
Borrowings	2,527	2,947	16.6%
Shareholder's Equity	9,708	10,765	10.9%
EBITDA	3,592	2,778	

Financial Ratios

Classification	'11	'12	Change
Total Liabilities/ Equity (%)	57.5	54.0	-3.5%p
Borrowings / Equity (%)	26.0	27.4	1.4%p
Interest Coverage Ratio (x)	42.0	25.7	-16.3
ROE (%)	24.7	14.7	-10.0%p
ROA (%)	15.5	9.5	-6.0%p

Business results

(Unit: KRW bn)

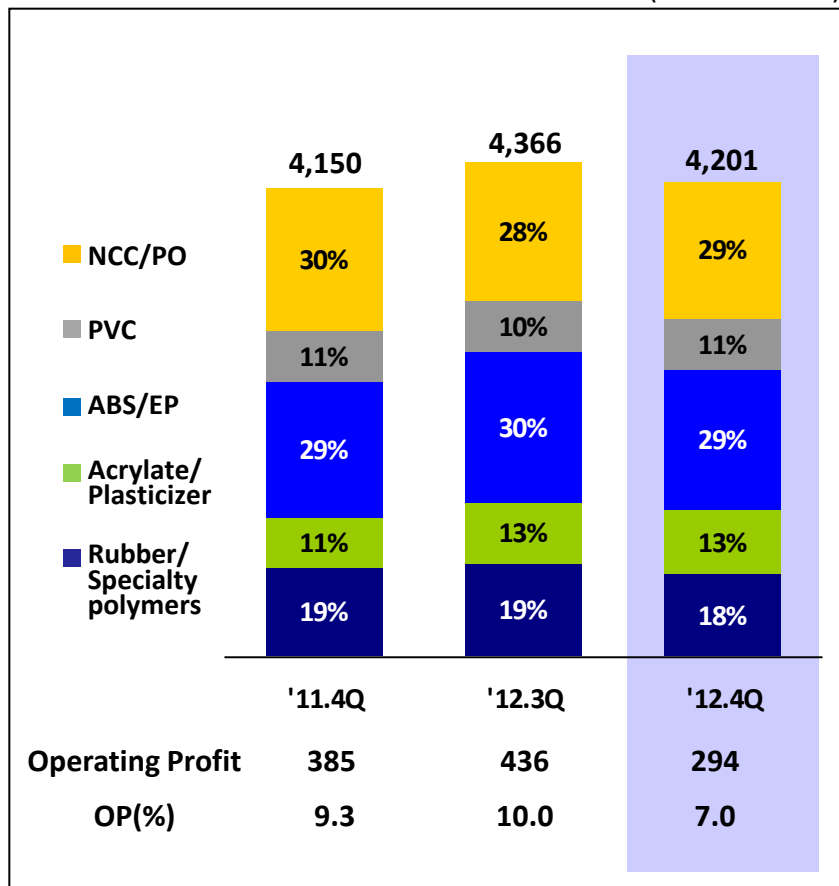

Analysis

• Analysis

■ Overall margin declined due to weak seasonal demand, rising feedstock costs and strengthening Korean won, etc

- NCC/PO : Recovery of PO product price slowed while naphtha price went up
- PVC : Margin squeezed due to influx of offshore supplies and weak seasonality
- ABS/EP : Narrowed spread by rising feedstock costs (mainly SM)
- Acrylate/Plasticizer : Achieved favorable business results by strong product price amid tightening of supply
- Rubber/Specialty Polymers : Margin declined due to price decrease by low utilization rate of tire industry and worsening demand for BPA

• Outlook

- Expect gradual recovery of product price and spread thanks to Chinese re-stocking demand after New Year's holiday
- Strengthen competitiveness through cost leadership and differentiated product portfolio by expanding premium products

Business results

Analysis

(Unit: KRW bn)

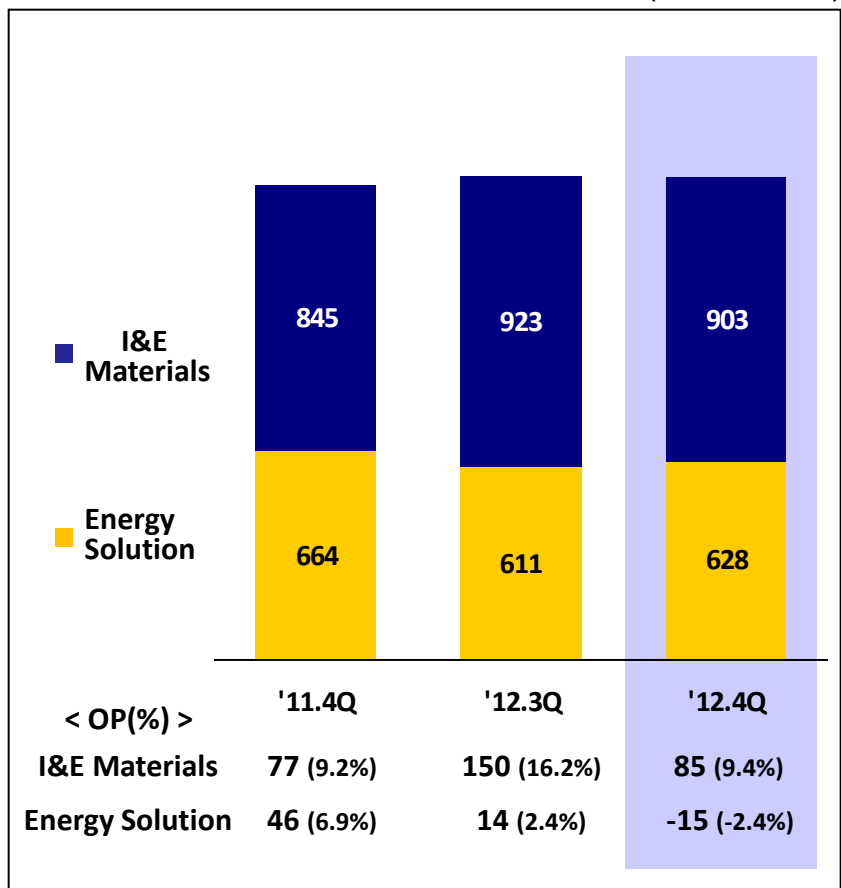

• Analysis

■ Diminished profits due to weak seasonality and one-off expense

- **I&E Materials** : While revenue decreased due to panel makers' year-end inventory adjustment, recorded relatively sound results thanks to 3D FPR sales increase
- **Energy Solution** : Recorded sluggish earnings due to weak Notebook PC demand and EV/HEV sales despite polymer battery sales increase for smartphones and Tablet PCs

• Outlook

■ Secure profitability and global leading position through changing product mix

- **I&E Materials** : Achieve sound results based on high margin products such as 3D FPR regardless of slow season
- **Energy Solution** : Expect gradual rise in automotive battery sales while shipments decrease of consumer batteries due to weak demand in IT devices during off-season

2013 Business Plan

Business Plan

(Unit: KRW bn)

Classification	'12	'13 Plan
Sales	23,260	24,860
Petro-chemicals	17,580	18,300
I&E Materials	3,450	3,900
Energy Solution	2,480	2,940
Operating Profits	1,910	-
CAPEX	2,070	2,120

Business Strategy

- Petrochemicals : Enhance business portfolio through technology**
 - **Promote market-driven business by differentiated technology**
 - Strengthen differentiated product portfolio by cultivating technology-based businesses such as SAP and SSBR, etc
 - **Seek investment opportunity with securing cheap feedstock and expanding business on emerging markets**
- I&E Materials : Expand high margin products & strengthen competitiveness of new business**
 - **Display Materials : Expand differentiated product lines**
 - Increasing high margin product sales including polarizers and 3D FPR
 - Beginning ITO film in earnest & growing OLED materials to meet new demands
 - **New Business**
 - Enhancing competitiveness of LCD glass through stabilizing production
 - Preparing for commercialization of OLED lighting
- Energy : Strengthen global leading position through differentiated products Solution & new market creation**
 - **Consumer Battery : Diversify application such as power tools and E-bike**
 - **Automotive Battery : Develop differentiated products with high performance and price competitiveness to lead the market**
 - Securing new customers & obtaining ESS projects

2013 Business Plan

Cash Flow

(Unit: KRW bn)

Classification	Amounts
Cash Inflow	2,840
From Operating	1,800
Depreciation	1,040
Cash Outflow	2,790
CAPEX	2,120
Working Capital & others	350
Dividend	320
Net Cash Flow	50

CAPEX

Classification	Amounts
Total	2,120
Type	
New / Expansion	1,360
Maintenance	760
Divisional	
Petrochemicals	790
I&E Materials	870
Energy Solution	220
Common	250

Key Investments

(Unit: KRW bn)

- Petrochemicals** 550
 - Yeosu : Expansion of SAP & CA/EDC
 - Daesan : Expansion of High EVA & SSBR

- I&E Materials** 740
 - Expansion of LCD glass substrates
 - 3D FPR, ITO film, polarizer, etc.

- Energy Solution** 70
 - Expansion of polymer battery

(Unit: KRW bn)

Classification	2011					2012				
	1Q	2Q	3Q	4Q	Total	1Q	2Q	3Q	4Q	Total
Sales	5,491	5,700	5,886	5,599	22,676	5,753	5,996	5,834	5,681	23,263
Operating Profit	831	763	717	508	2,819	447	499	601	364	1,910
Petrochemicals	4,276	4,328	4,570	4,150	17,325	4,491	4,521	4,366	4,201	17,579
NCC/PO	1,091	1,136	1,279	1,264	4,770	1,308	1,272	1,226	1,217	5,022
PVC	500	517	502	455	1,974	478	485	449	450	1,862
ABS/EP	1,347	1,318	1,293	1,208	5,166	1,312	1,325	1,320	1,234	5,191
Acrylate/Plasticizer	549	550	546	441	2,085	530	556	551	557	2,195
Synthetic Rubber/ Specialty Resin	789	807	950	783	3,330	864	883	819	743	3,310
Operating Profit	734	628	583	385	2,329	366	340	436	294	1,436
I&E Materials	807	891	800	845	3,343	761	864	923	903	3,452
Operating Profit	94	116	87	77	374	69	131	150	85	436
Energy Solution	468	561	576	664	2,269	562	677	611	628	2,479
Operating Profit	4	20	48	46	118	12	28	14	-15	39

※ Operating profits for 2011 and 2012 are amended to reflect revisions of "K-IFRS, No. 1001" decided on 19th regular Financial Services Commission's meeting on October 17th, 2012.

Borrowings

(Unit : KRW bn)

Classification	'11	'12
Total (Overseas Subsidiaries)	2,527 (1,044) 100%	2,947 (1,024) 100%
KRW Currency	475 19%	812 28%
C P	449	598
Others	27	214
Foreign Currency	2,052 81%	2,135 72%
Loan	1,124	1,140
Negotiation Borrowings	928	994
Short-term (Overseas Subsidiaries)	1,838 (679) 73%	1,752 (739) 59%
Long-term (Overseas Subsidiaries)	689 (365) 27%	1,195 (286) 41%

* The % is calculated to total borrowings.

Cash Flow

(Unit: KRW bn)

Classification	'11	'12
Beginning Cash	1,368	1,379
Operating/Investing	-96	-143
Net Income	2,170	1,506
Depreciation	757	868
Working Capital	-680	-147
CAPEX	-2,321	-2,075
Others	-22	-294
Financing	107	104
Borrowings	426	420
Dividends	-319	-316
Ending	1,379	1,341

(Unit: KRW bn)

Classification		'10	'11	'12 Plan	'12
Petrochemicals	New / Expansion	320	664	743	784
	Maintenance	266	296	269	226
	Total	586	960	1,012	1,009
I & E Materials	New / Expansion	425	330	539	242
	Maintenance	78	100	89	82
	Total	503	430	628	324
Energy Solution	New / Expansion	389	660	473	395
	Maintenance	85	105	139	101
	Total	474	765	612	496
Common Expenses	New / Expansion	-	-	-	16
	Maintenance	139	166	296	230
	Total	139	166	296	246
Total	New / Expansion	1,134	1,654	1,755	1,436
	Maintenance	568	666	794	639
	Total	1,702	2,321	2,548	2,075

(Unit:U\$/MT)

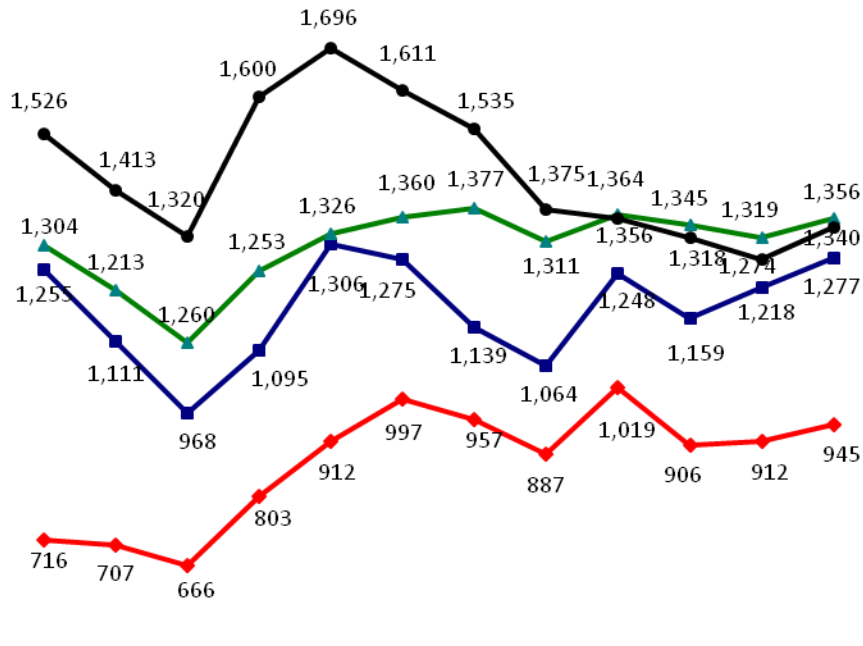

'10 1Q 2Q 3Q 4Q '11 1Q 2Q 3Q 4Q '12 1Q 2Q 3Q 4Q

◆ Naphtha ■ Ethylene ▲ HDPE(Film) ● LDPE

NCC/PO

(Unit:U\$/MT)

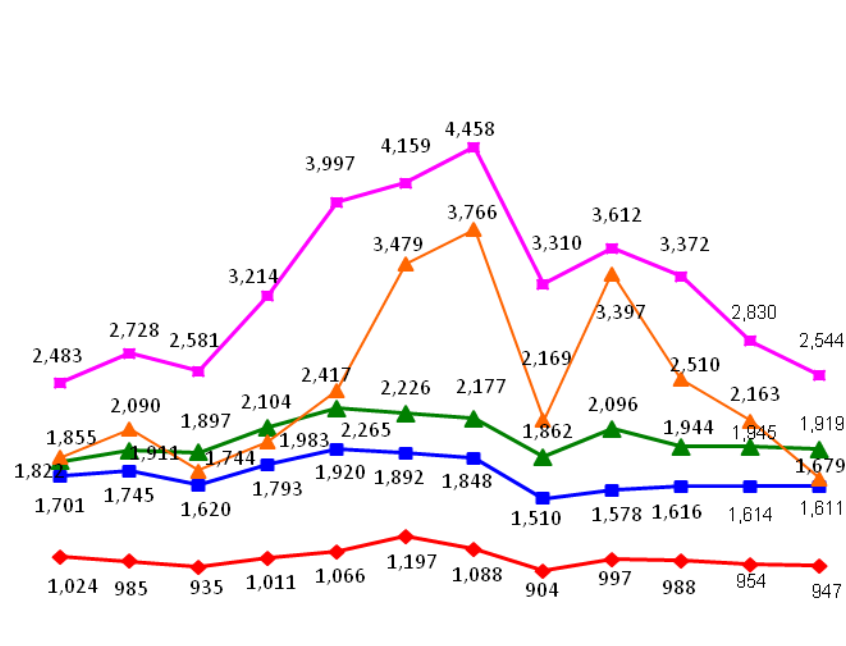

'10 1Q 2Q 3Q 4Q '11 1Q 2Q 3Q 4Q '12 1Q 2Q 3Q 4Q

◆ PVC ▲ ABS ■ Oxo-Alcohol ▲ BD ◆ BR

PVC

ABS/EP

**Acrylate/
Plasticizer**

**Rubber/
Specialty Polymers**

• The prices are average price of CFR FE Asia for general grade in each product group.

(Unit:U\$/MT)

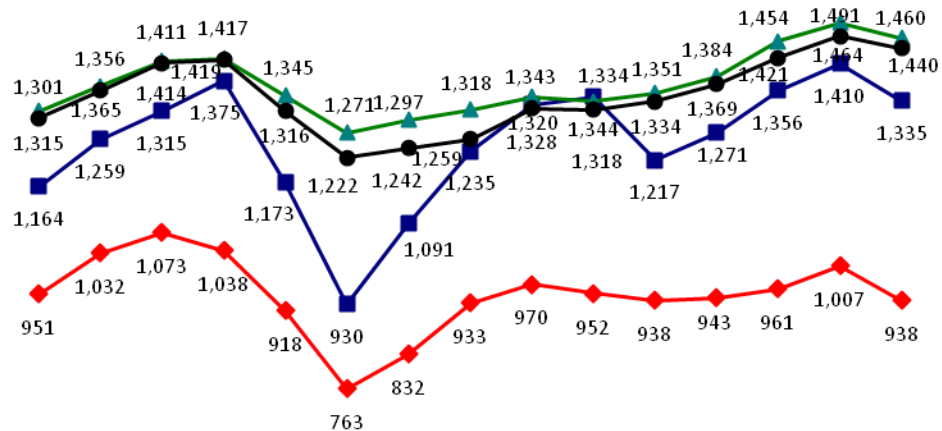

(Unit:U\$/MT)

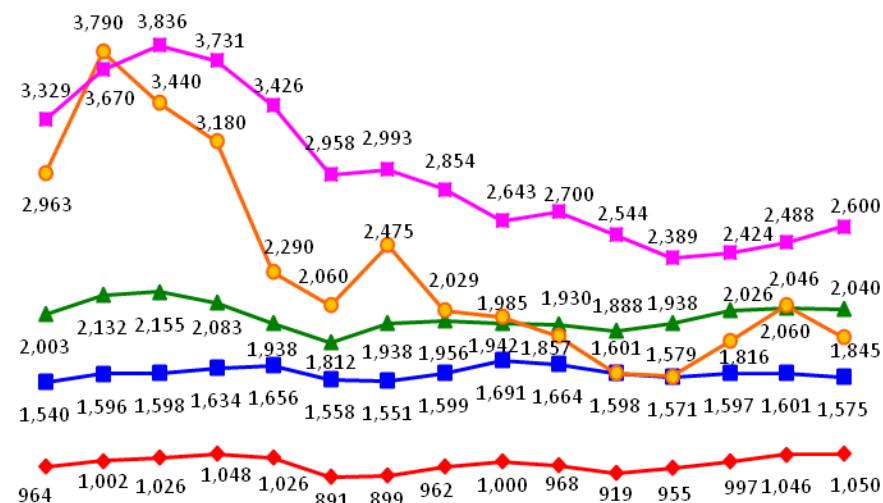

Jan Feb Mar Apr May Jun Jul Aug Sep Oct Nov Dec Jan '13 Feb Mar* '13

◆ Naphtha ■ Ethylene ▲ HDPE(Film) ● LDPE

NCC/PO

Jan Feb Mar Apr May Jun Jul Aug Sep Oct Nov Dec Jan '13 Feb Mar* '13

◆ PVC ▲ ABS ■ Oxo-Alcohol ● BD ◆ BR

PVC

ABS/EP

**Acrylate/
Plasticizer**

**Rubber/
Specialty Polymers**

• The prices are average price of CFR FE Asia for general grade in each product group.

* Shows the prices on Mar 11th, 2013

As of Mar, 2013

	Item	Location	Capa	Global Rank	Capa Addition('13)
Petro-Chemicals	ABS (Acrylonitrile-Butadiene-Styrene)	Korea, China	1,390 KMT/Yr	1st*	
	PVC (Polyvinyl Chloride)	Korea, China	1,270 KMT/Yr	6th	
	Oxo-Alcohol	Korea (Yeosu, Naju)	299 KMT/Yr	10th	
	AA (Acrylic Acid)	Korea (Yeosu, Naju)	353 KMT/Yr	6th	
	PC (Polycarbonate)	Korea (Yeosu)	170 KMT/Yr	6th	
	BR (Butadiene Rubber)	Korea (Daesan)	180 KMT/Yr	7th	
	Elastomer	Korea (Daesan)	85 KMT/Yr	4th	
	SAP (Super Absorbent Polymer)	Korea (Gimcheon, Yeosu)	180 KMT/Yr	6th	
	MBS (Methacrylate-Butadiene-Styrene)	Korea (Yeosu)	50 KMT/Yr	4th	
	NBL (Acrylonitrile-Butadiene-Latex)	Korea (Yeosu)	100 KMT/Yr	2nd	
I & E Materials / Energy Solution	BPA (Bisphenol A)	Korea (Yeosu)	450 KMT/Yr	5th	[150 KMT/Yr added on Jan]
	Polarizer	Korea (Ochang)	117 mn m ² /Yr	1st	[20mn m ² /Yr add on '13]
	Consumer Battery (Lithium-ion)	Korea (Ochang)	88 mn cells/Month**	3rd	[10 mn of Polymer add on '13]
	EV/HEV Battery (Lithium-ion)	Korea (Ochang)	130K Units/Yr***	1st	
	Color Filter Photoresists	Korea (Ochang)	-	2nd	
	3D FPR	Korea (Ochang)	-	1st	[2nd line add on 2Q]

* Actual Sales Base

** Cylindrical : 41 mn, Prismatic : 30 mn, Polymer : 17 mn

*** Convert to GM 'VOLT' base

Shareholders & Market Cap

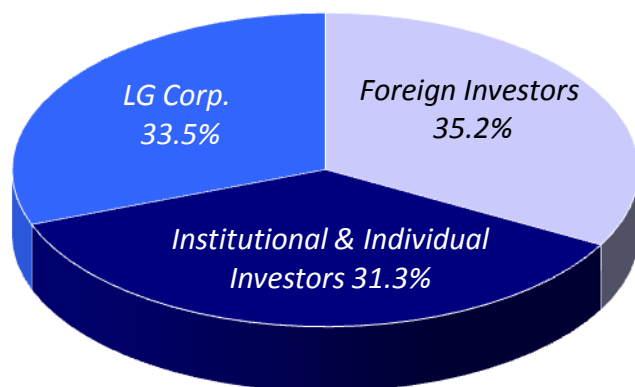

Common Stock as of Feb 28, 2013

(Unit : KRW)

	No. of Shares	Feb 28, '13	
		Price	Market Cap
Common	66,271,100	296,500	19.6 tn
Preferred	7,628,921	95,900	0.7 tn
Total	73,900,021		21.3 tn

Par value : KRW 5,000

Dividends

(Unit: KRW bn)

Classification	'11	'12	Change
Net Income	2,170	1,510	-30.41%
EPS(KRW)	29,360	20,384	-30.57%
Total Dividends	295*	295*	0
Dividend Payout Ratio	14.5%	20.4%	+5.9%p
Common Stock Price at year-end(KRW)	317,500	330,000	+12,500
Dividend Yield Ratio	1.3%	1.2%	-0.1%p

* Dividend of KRW 4,000 per common share